

Art.: 3110

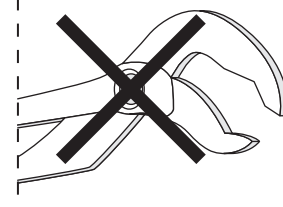

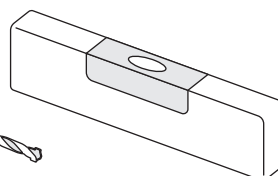
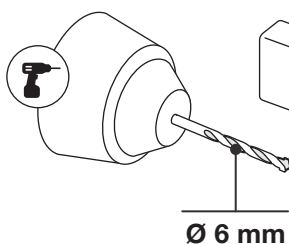
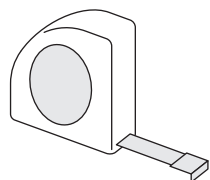
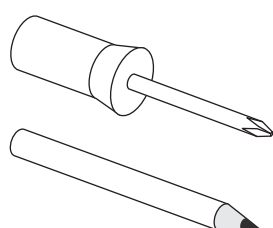
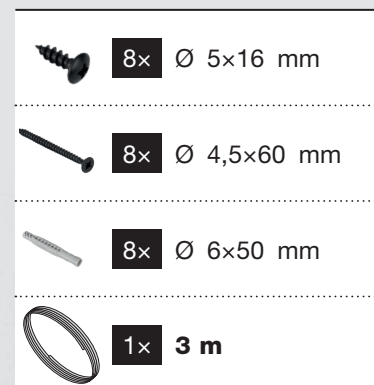
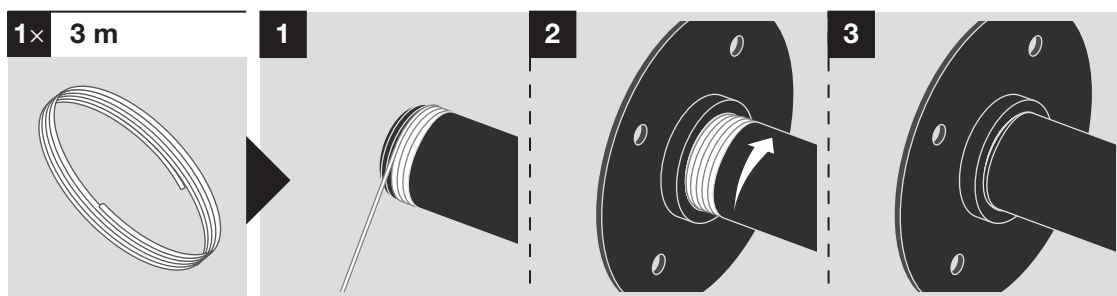
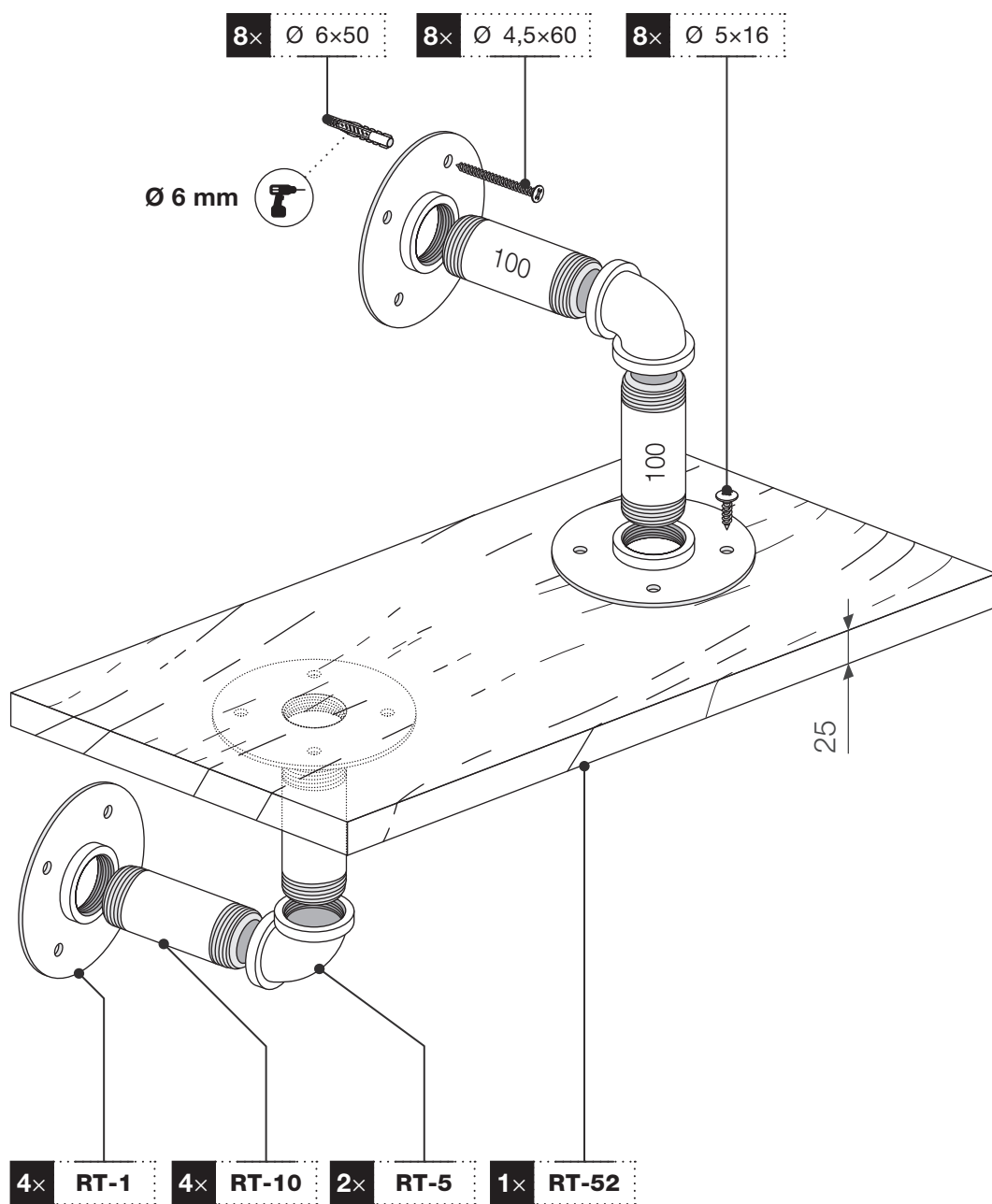

[mm]